



OUTDOOR GAS GRILL
USE AND CARE GUIDE



Contents

- 2 Safety Precautions
- 6 Outdoor Gas Grill Features
- 7 Grill Operation
- 9 Care Recommendations
- 10 Troubleshooting
- 11 Wolf Outdoor Warranty

Customer Care

The model and serial number are listed on the product rating plate. Refer to page 6 for rating plate location. For warranty purposes, you will also need the date of installation and name of your authorized Wolf dealer. Record this information below for future reference.

SERVICE INFORMATION

Model Number
Serial Number
Date of Installation
Certified Service Name
Certified Service Number
Authorized Dealer
Dealer Number

Important Note

To ensure this product is installed and operated as safely and efficiently as possible, take note of the following types of highlighted information throughout this guide:

IMPORTANT NOTE highlights information that is especially important.

CAUTION indicates a situation where minor injury or product damage may occur if instructions are not followed.

WARNING states a hazard that may cause serious injury or death if precautions are not followed.

Australia Only

CONTACT INFORMATION
 Sub-Zero Group Australia Pty Ltd
 Level 10, 469 La Trobe Street
 Melbourne Victoria 3000
 Phone 03 9600 2218
 subzero-wolf.com.au

SAFETY PRECAUTIONS

IMPORTANT SAFEGUARDS

⚠ WARNING

This appliance can be used by children aged from 8 years and above and persons with reduced physical, sensory or mental capabilities or lack of experience and knowledge if they have been given supervision or instruction concerning use of the appliance in a safe way and understand the hazards involved. Children shall not play with the appliance. Cleaning and user maintenance shall not be made by children without supervision.

⚠ WARNING

Wolf outdoor products are for outdoor use only! Do not operate in enclosed areas. This could result in carbon monoxide buildup which would result in injury or death.

⚠ WARNING

Accessible parts may be very hot. Keep young children away.

⚠ WARNING

Read the instructions before using the appliance.

SAFETY PRECAUTIONS

IMPORTANT SAFEGUARDS



WARNING

If the information in this guide is not followed exactly, a fire or explosion may result, causing property damage, personal injury or death.

Australia Only

Suitable only for Outdoor Installation

- Do not place articles on or against this appliance.
- Do not spray aerosols in the vicinity of this appliance when it is in operation.
- Improper Installation, adjustment, alteration, service or maintenance can cause property damage, injury or death. Read installations thoroughly before installing or servicing this equipment.
- When in use portions of your grill will become hot enough to cause severe burns. Children and pets should never be left alone or unattended in the area where the grill is being used. Never allow children to sit, stand or play near the grill.
- Do not store items of interest to children in or around the grill.
- All service must be carried out by an authorised Wolf Service Agent
- Do not use any cleaner, including water, on a hot grill
- This appliance shall only be used in an above ground open-air situation with natural ventilation, without stagnant areas, where gas leakage and products of combustion are rapidly dispersed by wind and natural convection.
- Any enclosure in which the appliance is used shall comply with one of the following: An enclosure with walls on all sides, but at least one permanent opening at ground level and no overhead cover. Within a partial enclosure that includes an overhead cover and no more than two walls. Within a partial enclosure that includes an overhead cover and more than two walls, the following shall apply - (i) at least 25% of the total wall area is completely open; and (ii) at least 30% of the remaining wall area is open and unrestricted. (iii) In the case of balconies, at least 20% of the total of the side, back and front wall areas shall be and remain open and unrestricted.

WHAT TO DO IF YOU SMELL GAS:

- Shut off gas to the appliance.
- Extinguish any open flames.
- Open hood or remove cover.
- If odor continues, keep away from the appliance and immediately call your gas supplier or fire department.

FOR OUTDOOR USE ONLY:

If stored indoors, detach and leave LP cylinder outdoors.

FOR YOUR SAFETY:

- Do not store or use gasoline or other flammable vapors and liquids in the vicinity of this or any other appliance.
- An LP cylinder not connected for use shall not be stored in the vicinity of this or any other appliance.
- Keep any electrical supply cord and the fuel supply hose away from any heated surfaces.
- The appliance must be kept away from flammable materials during use.

BEFORE LIGHTING:

- Read instructions before lighting.
- Open hood or remove cover before lighting.
- If ignition does not occur in 5 seconds, turn the burner control(s) off, wait 5 minutes, and repeat the lighting procedure.

SAFETY PRECAUTIONS

IMPORTANT SAFEGUARDS

- Read this use & care guide carefully before using your outdoor product to reduce the risk of fire, electric shock or injury to persons.
- Installation must be performed by a qualified installer, service agency or the gas supplier.
- Warranty service must be performed by Wolf factory certified service.
- Make sure the outdoor product is properly installed and connected to the gas for which your unit was designed. Do not use charcoal or other material in your outdoor product.
- Make sure the outdoor product is connected to a properly grounded RCD 220-240 electrical supply.
- Have the installer show you where the gas shut-off valve is so you can shut off the gas supply in an emergency.
- If the smell of gas is present, gas connections may not be properly sealed or you may have a gas leak. Determining where the gas leak is should be done by Wolf factory certified service or the gas supplier.
- Do not modify the appliance.
- The installation of this appliance must conform with local codes.
- Minimum clearance of 305 mm from the back and sides of the grill to adjacent combustible construction must be maintained. This outdoor cooking gas appliance should not be located under overhead unprotected combustible construction.
- The utilization of an external electrical source requires that when installed, this outdoor cooking gas appliance must be electrically grounded in accordance with the local codes. Keep any electrical supply cord, or the rotisserie motor cord and the fuel supply hose away from any heated surfaces.

SAFETY PRECAUTIONS

IMPORTANT SAFEGUARDS

- It is critical that the gas burners are properly installed with their orifices inside the burners air shutters. If not properly installed, gas may leak outside of the burner that could lead to fire, potential damage to your grill and bodily injury.
- When choosing an area for the grill, whether a portable or built-in application, consider exposure to wind, proximity to traffic paths and length of the gas supply line.
- Do not move appliance during use.
- Turn off gas supply to cylinder after each use.
- LP cylinder must be disconnected when not in use.
- This outdoor cooking gas appliance is not intended to be installed in or on recreational vehicles and/or boats.
- Do not obstruct the flow of combustion and ventilation air to this appliance. Keep the ventilation openings of the cylinder enclosure free and clear from debris.
- Do not install in, or connect to the consumer piping or gas supply system of a boat or caravan.
- **DO NOT USE AN ADAPTOR AT THE CYLINDER CONNECTION**
- Check all gas connections for leaks with soapy water solution and brush. Never use an open flame. Refer to the outdoor gas grill installation guide for the leak testing procedure.
- Check flexible hoses for cuts and wear that may affect the safety before each use. **Hoses and regulators should be inspected regularly and replaced if damaged or leaking.**
- Never light the outdoor product with cover in place.
- Never use the grill without the drip pan installed and pushed all the way to the back of the grill.
- Never fill an LP cylinder beyond 80% full.
- It is recommended that protective gloves be used when handling hot components.
- Parts sealed by the manufacturer shall not be manipulated by the user.

Outdoor Gas Grill Features

FEATURES

- 1 Product Rating Plate
- 2 Sear Zone Knob
- 3 Grill Burner Knob
- 4 Rotisserie Knob
- 5 Hood
- 6 Thermometer
- 7 Burner Grates
- 8 Warming Rack
- 9 Rotisserie Motor
- 10 Rotisserie Burner
- 11 Interior and Knob Light Button
- 12 Drip Tray

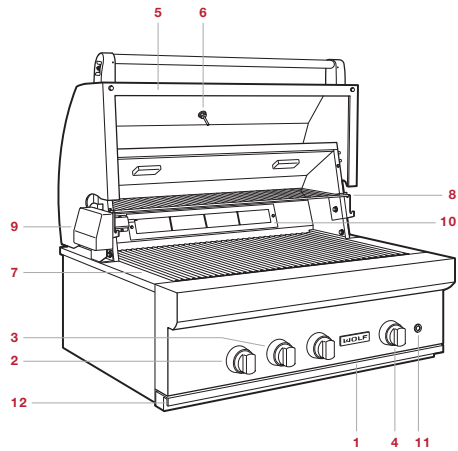

Outdoor gas grill (model ICBG36 shown).

Outdoor Module Features

FEATURES

- 1 Product Rating Plate
- 2 Control Knob
- 3 Burner Grates
- 4 Knob Light Button (burner module)

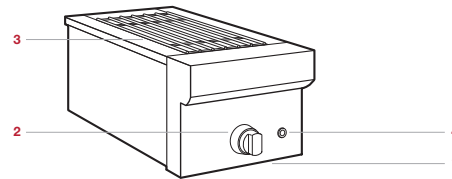

Outdoor module (burner module shown).

Outdoor Grills and Modules

For portable applications, Wolf grill carts are designed specifically to fit grill models ICBG30, ICBG36 and ICBG42 and the side burner. Model ICBG54 is designed for built-in applications only.

Wolf outdoor grills and the burner module are designed for easy placement into a built-in enclosure. For outdoor grills, installation in a combustible enclosure requires an insulating liner. For the burner module, an insulating liner is not required.

For built-in applications, stainless steel accessory doors and drawers are available through an authorized Wolf dealer.

BURNER RATING

GRILL BURNERS

ICBOG30, ICBG36, ICBG42, ICBBM13, ICBSB13	7.3 kW
ICBOG54	7.5 kW

SEAR ZONE

ICBOG36, ICBG42	7.3 kW
ICBOG54	7.5 kW

ROTISSERIE

ICBOG30	4.1 kW
ICBOG36, ICBG42	4.7 kW
ICBOG54	(2) 4.1 kW

Australia Only	Nat Mj	Propane Mj
Grill Burners		
ICBOG30/36/42	29	28
ICBOG54	29	30
Sear Burner		
ICBOG30/36/42	29	28
ICBOG54	29	30
Rotisserie Burner		
ICBOG30/36	15	15
ICBOG42	17	17
ICBOG54	2 x 15	2 x 15
Wok Burner		
ICBBM13	25	24

Getting Started

We know you are eager to start grilling, but before you do, please take some time to read this use & care guide. Whether you are an occasional cook or an expert chef, it will be to your benefit to familiarize yourself with the safety practices, features, operation and care recommendations of your Wolf outdoor gas grill.

- To ensure all residual oil from the manufacturing process has been removed, turn burner control knobs to 🔥 and allow grill to heat for 10 minutes with hood closed. A small amount of smoke and odor may be noticed during the initial break-in period.
- Clean the grill thoroughly with hot water and mild detergent prior to use. Rinse and dry with a soft cloth. Refer to care recommendations on page 9.
- Verify all components are assembled correctly.
- Wolf outdoor products are manufactured for use with natural gas or LP gas. Check the product rating plate for the type of gas for your specific model. If this appliance does not correspond to your type of gas, contact your authorized Wolf dealer.

Grill Operation

BURNER LIGHTING

- 1 Open hood completely. Do not attempt to light the grill with hood closed. For module, remove cover.
- 2 Open gas supply shut-off valve.
- 3 Push in burner control knob and verify the hot surface igniter glows. Hot surface igniters are located below the burner grates inside the flash tubes (for module, at the rear of the burner). Refer to the illustrations below.
- 4 Once a glow is verified, push in and turn control knob counterclockwise to 🔥. Hold knob in for five seconds. Once a flame is visible, release knob. If the burner fails to light within five seconds, turn knob to ○, wait five minutes and repeat lighting procedure.
- 5 Close hood and allow the grill to preheat until desired temperature is displayed on the thermometer.

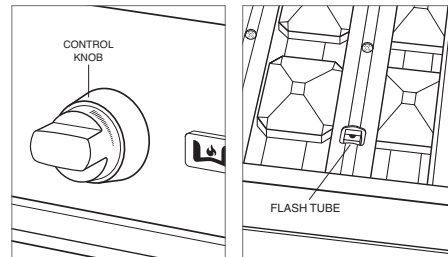

Burner control knob.

Flash tube location.

MANUAL LIGHTING

If electrical power is not available, surface burners can be lit manually using a multi-purpose lighter.

- 1 Open hood completely. Do not attempt to light the grill with hood closed. For module, remove cover.
- 2 Open gas supply shut-off valve.
- 3 Push in and turn control knob counterclockwise to 🔥. Hold knob in for five seconds.
- 4 Insert multi-purpose lighter (or match held by the lanyard provided) through burner grates and near the top of the flash tube (for module, near the top of the burner). Once a flame is visible, release knob. If the burner fails to light within five seconds, turn knob to ○, wait five minutes and repeat lighting procedure.

⚠ WARNING

When lighting, always keep face and body as far away as possible.

GENERAL GRILLING

- 1 After lighting, allow grill burners to preheat for 10 minutes on desired heat setting.
- 2 Place food on the grill and cook to desired temperature or doneness, turning food halfway through cooking time. Adjust heat setting if necessary. The burner control knob may be set to any position between 🔥 and 🔥.
- 3 Remove food or transfer to warming rack to keep warm.
- 4 Allow grill to cool. Clean the drip tray after each use.

INFRARED SEAR BURNER

Searing steaks and other meats over the infrared sear burner to begin grilling helps seal in flavorful juices. Sear meats quickly, followed by regular grilling over grill burners.

- 1 After lighting, allow the infrared sear burner to preheat for 10 minutes on 🔥.
- 2 Sear meat up to two minutes on each side, then move food to grilling area.

AUSTRALIA ONLY
WARNING: SOLID PLATE MUST BE FITTED OVER SEAR BURNER

Australia Only Model with solid plate installed over sear burner

OUTDOOR GRILL
Model OG38 shown

Refer to appliance dateplate for further technical information located under grease tray

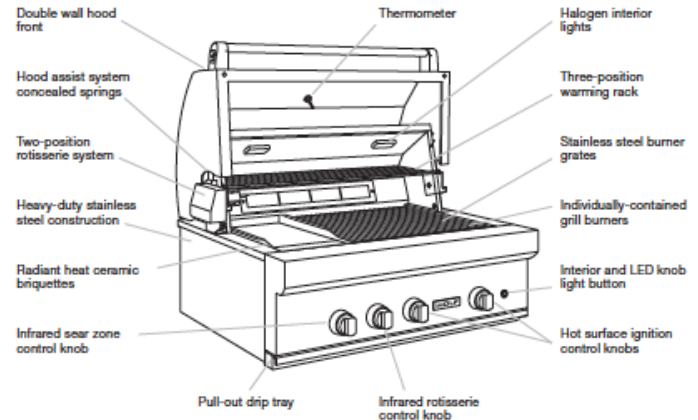

Grill Operation

ROTISSERIE GRILLING

The rotisserie rotates food in front of an infrared burner for even cooking and a more juicy taste. Additional radiant heat from the outside grill burners on 🔥, may be used to speed up cooking time. The hood must be closed. Use for grilling large roasts and whole poultry. It is recommended that protective gloves be used when handling hot components.

When not in use, the rotisserie motor should be stored in a protected area.

- 1 Install rotisserie motor on the motor bracket and plug it into the electrical outlet.
- 2 Insert food in the middle of the spit rod and secure with meat forks on both ends by tightening thumb screws. Make sure food is evenly balanced.
- 3 Insert spit rod in the rotisserie motor at desired position.
- 4 Place basting pan under food to catch drippings.
- 5 Push in and turn rotisserie knob counterclockwise to 🔥. Rotisserie igniter is located on the rear panel next to the rotisserie burner. Refer to the illustration below.
- 6 Close hood and allow the rotisserie burner to preheat for 10 minutes on desired heat setting.
- 7 Place spit rod with food into the rotisserie motor. Cook to desired temperature or doneness.
- 8 To remove spit rod, lift slightly on the rotisserie motor and pull rod out.

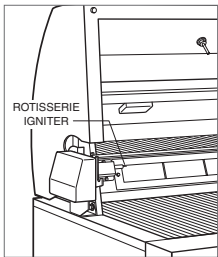

Rotisserie igniter.

ROTISSERIE POSITION

The two-position rotisserie allows for food of different sizes to cook at the proper distance from the infrared rotisserie burner. Maximum load is 11 kg.

- 1 Install rotisserie motor in the low position for large loads or high position for small loads. Refer to the illustrations below. The motor socket hole will line up with the lower notch of the spit saddles in low position and upper notch in high position.
- 2 Insert spit rod into the motor socket hole and place rod on the appropriate notch of each spit saddle.
- 3 For large loads, remove burner grates and place basting pan on top of the briquette trays to catch drippings. For small loads, place basting pan on top of the burner grates.

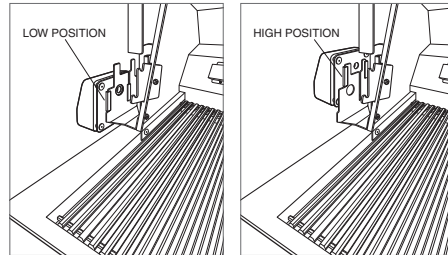

Low rotisserie position.

High rotisserie position.

Caution -

ICBOG54

When cooking with the hood closed only the middle 2 burners should be in operation and turned down to maintain a maximum of 230 C.

Maximum cooking temperature with hood closed should not exceed 230C **ICBBM13**

Maximum pot size for Built in Burner is 270mm.

Light burner before placing the vessel in position over the burner.

WARMING RACK

The warming rack has three positions. Warm food in the high or low position, or when not in use, place on the top support hooks for storage position. Refer to the illustration below.

From the high position, the warming rack must be removed and rotated 180° for low position and storage position. The warming rack must be removed or in the storage position during rotisserie operation.

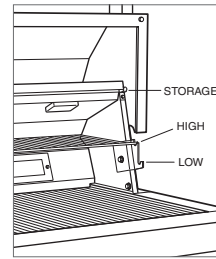

Warming rack.

SMOKER BOX

The sealed smoker box included with the grill, can hold soaked wood chips to smoke enhance foods. The smoker box may warp slightly with heat, but will retain its original shape after it cools.

- 1 Remove one burner grate section and slide remaining sections aside so the center is exposed. Remove a center half-size briquette tray without flash tube.
- 2 Position smoker box in place of the briquette tray. Smoker box will line up above the burner. For best results, center smoker box in the grill.
- 3 Add soaked wood chips to the smoker box.
- 4 Turn control knob for the burner under the smoker box on 🔥. Once smoking begins, turn heat to desired setting.
- 5 Position burner grate section over the smoker box and place food directly on the grate.
- 6 Every 30 to 45 minutes, slide grate section aside to access the smoker box. Stir wood chips and add more if needed.
- 7 Cook food to desired temperature, doneness or smoke enhancement.

⚠ CAUTION

Do not use the smoker box over the infrared sear burner.

CARE RECOMMENDATIONS

Grill Lights

Outdoor gas grills are equipped with halogen interior lights and LED lights in the control knobs for night grilling.

Turn interior and knob lights on and off using the button located on the front panel of the grill. Interior lights turn off automatically when the hood is closed but the control knob lights will remain on.

Interior lights require 10W, type G4 halogen bulbs and are available through an authorized Wolf dealer.

LIGHT BULB REPLACEMENT

IMPORTANT NOTE: Use a paper towel when handling the replacement halogen bulb to keep oil on fingers from touching the bulb. Failure to do this will shorten the life of the bulb.

- 1 Unplug grill from the electrical outlet and allow the halogen bulb to cool before replacing.
- 2 Remove the light cover lens, by pushing in on one of the side retaining brackets with a screwdriver.
- 5 Remove the old halogen bulb by pulling it straight out.
- 6 Using a paper towel to handle the new halogen bulb, insert bulb securely into the socket and replace the light cover lens.

▲ CAUTION

Use caution when handling light bulbs. Halogen bulbs get hot instantly and adjacent parts may retain heat.

Care Recommendations

CLEANING

Stainless steel	After grill has cooled, use a nonabrasive stainless steel cleaner and apply with a soft lint-free cloth. To bring out the natural luster, lightly wipe surface with a water-dampened microfiber cloth followed by a dry polishing chamois. Always follow the grain of stainless steel. Baked-on residue can be removed using a mild abrasive pad with stainless steel cleaner. Do not use steel wool. It is normal for certain areas of the stainless steel to discolor due to intense heat given off by the burners.
Grill interior	Turn all grill burners on 🔥 (including sear, but not rotisserie burner). Allow grill to heat for 10–12 minutes with hood closed. Turn burners off and allow grill to cool completely. Remove burner grates and briquette trays. Cover burner tubes and infrared sear burner with plastic wrap and clean interior with oven cleaner according to directions.
Burner grates	While grates are still hot, scrub with grill brush and water. The steam created will loosen food particles on briquettes and drip tray. Do not clean the burner grate section while in place over the infrared sear burner. Liquid should not come in contact with the sear burner. Grates may be rotated for cleaning.
Grill burners	Inspect grill burners for spiders, insects and other obstructions periodically. Clear obstructions. IMPORTANT NOTE: Spiders and insects can nest in burners causing a fire hazard and damage to the grill.
Infrared sear burner	Clean the protective screen of the sear burner and remove trapped particles periodically. To avoid damage to ceramic tiles, do not allow liquid to come in contact with the infrared sear burner. Do not place briquette trays over the sear burner.
Ceramic briquettes Briquette trays	Turn all grill burners on 🔥 (including sear, but not rotisserie burner). Allow grill to heat for 10–12 minutes with hood closed. Turn burners off and allow grill to cool completely. Remove briquette trays and wipe clean.
Smoker box	After grill has cooled, remove smoker box, empty and clean with warm water and mild detergent.
Drip tray	After grill has cooled, slide drip tray out and wipe clean. To avoid a grease fire, drip tray should be cleaned after each use.

Troubleshooting

Burners do not light.

- Push burner control knob in and verify igniter glows.
- Verify electrical power to grill and home circuit breaker is on.
- Verify GFCI/RCD has not been tripped.
- Purge line of trapped air.
- If no electrical supply is available, burners can be lit manually. Refer to page 7.

Hot surface igniter does not operate.

- Verify electrical power to grill and home circuit breaker is on.
- Verify GFCI/RCD has not been tripped.

Burners do not heat properly.

- Verify proper gas supply.
- Verify gas supply line is not bent or kinked.
- Preheat burners for 10 minutes.
- Inspect grill burners and venturis for spiders, insects or other obstructions.

⚠ WARNING

Spiders and insects can nest in burners causing a fire hazard and damage to the grill.

Burner flame blows out.

- Verify proper gas supply.
- If exposed to wind, provide a wind block.

Smell of gas is present.

- Contact Wolf factory certified service or gas supplier to check for gas leak.

Excessive flare-ups occur.

- Clean burner grates.
- Excess fat on meat or excessive cooking temperature.

Interior or control knob lights do not operate.

- Verify electrical power to grill and home circuit breaker is on.
- Verify GFCI/RCD has not been tripped.
- Interior light bulb may need to be replaced.

SERVICE

To ensure that your Outdoor Grill is operating efficiently it is recommended that once every 12 months a routine maintenance service is completed by an authorised Wolf Agent.

- Maintain the quality built into your product by contacting Wolf factory certified service.
- When contacting service, you will need the model and serial number of your product. Both numbers are listed on the product rating plate. Refer to page 6 for rating plate location.
- For warranty purposes, you will also need the date of installation and name of your authorized Wolf dealer. This information should be recorded on page 2.

Australia Only

CONTACT INFORMATION

Sub-Zero Group Australia Pty Ltd
Level 10, 469 La Trobe Street
Melbourne Victoria 3000
Phone 03 9600 2218
subzero-wolf.com.au

Wolf Appliance International Limited Warranty

FOR RESIDENTIAL USE

These Warranty Terms and Conditions ("Warranty") constitute your agreement with Sub-Zero Group Australia Pty Ltd (ACN 610 807 899) ("Wolf") and will apply to your service order. The benefits given by this Warranty are in addition to all consumer guarantees and other rights and remedies prescribed by the Australian Consumer Law and any other applicable laws.

Our products come with guarantees that cannot be excluded under the Australian Consumer Law. You are entitled to a replacement or refund for a major failure and compensation for any other reasonably foreseeable loss or damage. You are also entitled to have the goods repaired or replaced if the goods fail to be of acceptable quality and the failure does not amount to a major failure.

In addition to your rights and remedies under the Australian Consumer Law, Wolf provides customers with a Warranty where, if any part of a Wolf product is found upon inspection by an authorised Wolf representative or an associated licensed technician supplied by either Wolf or a relevant approved supplier (including a Wolf factory certified service) ('Service Representative') to be defective in materials or workmanship, Wolf will repair and replace the part as follows:

FULL TWO YEAR WARRANTY* (Outdoor product full one year warranty)**

For two years from the date of original installation, this Wolf Appliance product warranty covers all parts and labour to repair or replace, under normal residential use, any part of the product that proves to be defective in materials or workmanship. All service provided by Wolf Appliance under the above warranty must be performed by Wolf factory certified service, unless otherwise specified by Wolf Appliance, Inc. Where the Service Representative is unable to identify any fault in the product, Wolf may require the consumer to provide proof that the product is defective. For the avoidance of doubt, defective products or parts become Wolf's property. Service will be provided during normal business hours.

LIMITED FIVE YEAR WARRANTY

For five years from the date of original installation, Wolf Appliance will repair or replace the following parts that prove to be defective in materials or workmanship: gas burners (excludes appearance), electric heating elements, blower motors (ventilation hoods), electronic control boards, magnetron tubes and induction generators. If the owner uses Wolf factory certified service,

the service provider will repair or replace the above listed parts at no cost with the owner paying for all other costs, including labour. If the owner uses non-certified service, the owner must contact Sub-Zero Group Australia, (using the information below) to receive repaired or replacement parts. Wolf Appliance will not reimburse the owner for parts purchased from non-certified service or other sources.

TERMS APPLICABLE TO EACH WARRANTY

The warranty applies only to products installed for normal residential use. This warranty does not cover any parts or labour to correct any defect caused by negligence, accident or improper use, maintenance, installation, service or repair.

CLAIM PROCEDURE

In order to claim the Warranty, you must cease using the product when a fault arises, contact Sub-Zero or authorised Sub-Zero dealer where the product was purchased to report the issue and follow Sub-Zero's directions regarding what to do next. Sub-Zero's general contact details are as follows:

Sub-Zero Group Australia
11-19 Bank Place
Melbourne VIC 3000
Phone: 03 9600 2218 email: serviceAU@subzero.com

EXCLUSIONS

Except to the extent required by law, all consumer guarantees, representations, warranties, terms and conditions in relation to the products (whether implied or otherwise) are hereby excluded to the maximum extent permitted by law.

To the fullest extent permitted by law, Wolf excludes all liability for damage or injury to any person, damage to any property and any indirect consequential or other loss or damage.

*Stainless steel (doors, panels, handles, product frames and interior surfaces) are covered by a limited 60-day parts and labour warranty for cosmetic defects.

** Full one year warranty applies to outdoor product. Product must be approved for outdoor use, designated by model and serial number.

