

ICBSPO30TE/S/TH

FEATURES

Rigorously tested for decades of use

Exceptional support from our Customer Care team

Combines microwave, convection, and grill technologies to provide all-in-one oven versatility

Assures predictably delicious results with 10 microwave power levels, convenient quick-start modes, and an intuitive Gourmet mode

Provides more cooking power than a traditional microwave with the help of convection and grill

Fits a 33x23cm pan in the 46 L capacity, stainless-steel interior

Frees up counter space with efficient drop-down door design

Micro Bake and Micro Roast modes reduce or completely eliminate preheat times

Coordinates with other Wolf built-in ovens and appliances with various handle and trim options



PRODUCT SPECIFICATIONS

Model	ICBSPO30TE/S/TH
Dimensions	759mmW x 454mmH x 546mmD
Capacity	46 L
Door Clearance	360mm
Weight	36 kg
Power Cord Length	1.8 Meters
Receptacle	grounding-type (earthed), IEC inlet

NOTE: Dimensions in parenthesis are in millimeters unless otherwise specified

DIMENSIONS

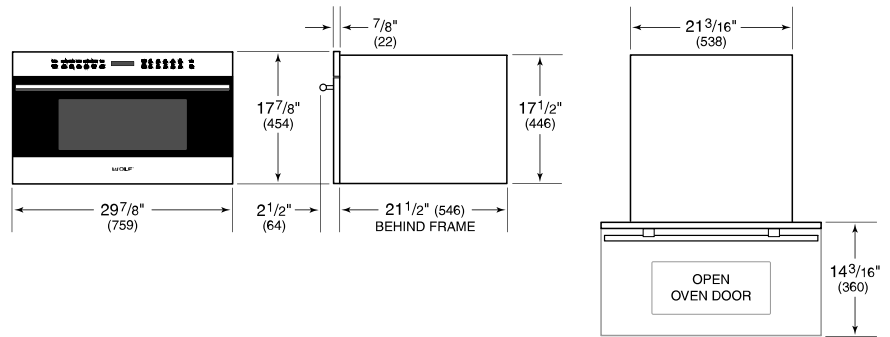

STANDARD INSTALLATION

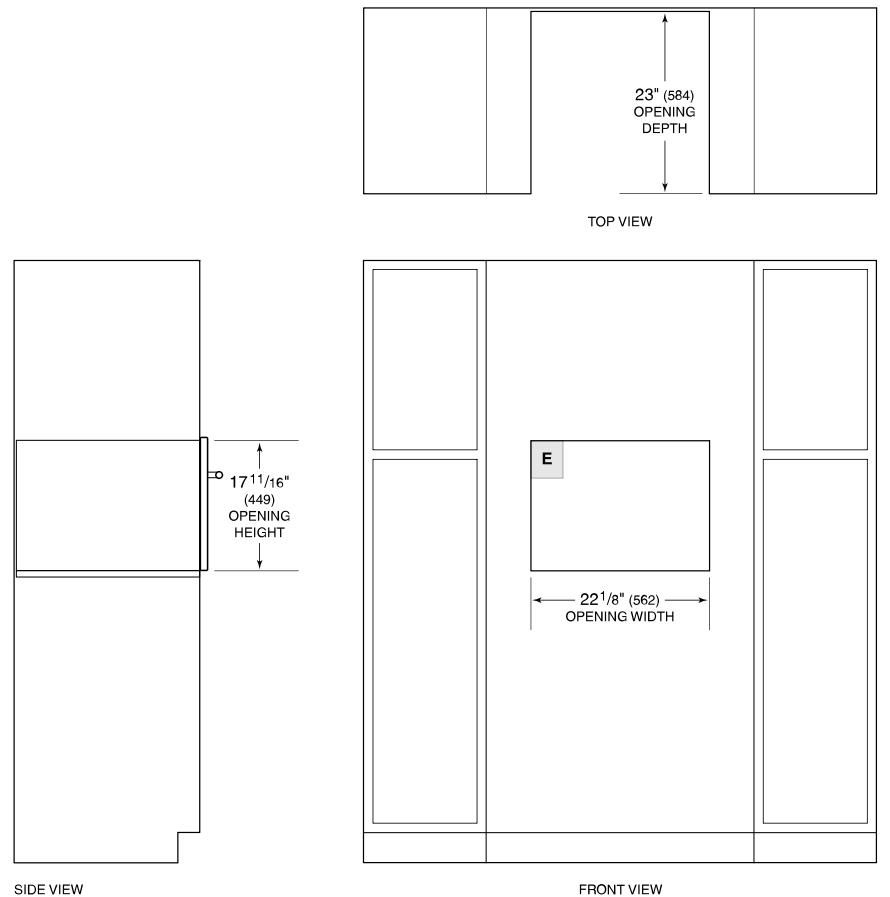

NOTE: 24" (610) and 30" (762) models require the same opening dimensions.